

DS8B Series Intelligent Sensor Meter Instruction Manual

Thanks a lot for selecting products!
 Before operating this instrument, please carefully read this manual and fully understand its contents.
 If have problems, please contact our sales or distributors whom you buy from. This manual is subject to change without prior notice.

Warning

Please do not turn on the power supply until all of the wiring is completed. Otherwise electrical shock, fire or malfunction may result.
 Do not wire when the power is on. Do not connect the unused terminals. Do not turn on the power supply when cleaning this instrument. Do not disassemble, repair or modify the instrument. This may cause electrical shock, fire or malfunction.
 Use this instrument in the scope of its specifications. Otherwise fire or malfunction may result.
 The use life of the output relay is quite different according to its capacity and conditions. If use out of its scope, fire or malfunction may result.

Caution

This instrument should be installed in a domestic environment. Otherwise electrical shock, fire or malfunction may result. The operating temperature environment should be between 0 (32F) to 50 (122F).
 To avoid using this instrument in environment full of dust or caustic gas.
 To avoid using this instrument in environment of strong shock or concussion.
 To avoid using this instrument in environment of overflow water or explosive oil.
 Output should start in about 10 seconds after power on when the instrument has control output function.

Applications

The instrument can measure any range of Current or Voltage signal input. The user can select data remained or top value remained. The instrument can be use with 2 wire transmitter, pressure sensor, 4-wire weight sensor and so on. For non-linear heat input, the instrument can process for 20 stages.
 As well the instrument can be with RS485 communication. The input, output and the power supply is isolated.

Name of parts

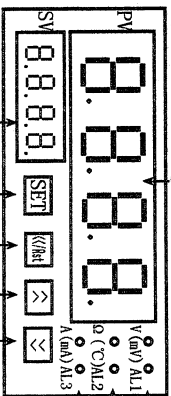

- Measured value (PV)/Various parameter symbols
 - Parameter value/Rate value/cv/AL1
 - Indication lamps for Alarm 1 (VdV)
 - AL1 On: Output Off: No alarm
 - Indication lamps for Alarm 2 Ω (C)
 - AL2 On: Output Off: No alarm
 - Select/Confirm key
 - Shift/Clear /Reset key
 - Up key
 - Down key
- ★ Input Signals selection

Input signal types	Range	Input impedance	Factory setting
mA	0~1mA, 0~10mA, 4~20mA	$\leq 150\Omega$	mA
V(AV/DV)	0~50, 0~10V, 0~500V	$\leq 20K\Omega$	DC 0~10V
mV	0~4000, 0~100mV	$\leq 2M\Omega$	DC 0~15mV
Rt	0.50, 0.100, -50~150°C	$\leq 0.2mA$	0~400°C
Pt	-200~650°C	$\leq 0.2mA$	Pt-100
TC	K: 0~1320°C J: 0~1300°C E: 0~1000°C T: -150~400°C B: 0~1820°C R: 0~1700°C S: 0~1600°C	$\leq 2M\Omega$	K

★ High Voltage/Current input or data remained function need special order.

★ AL3 also can be use as analogue output, but you can select only one of them, but not both.

Models

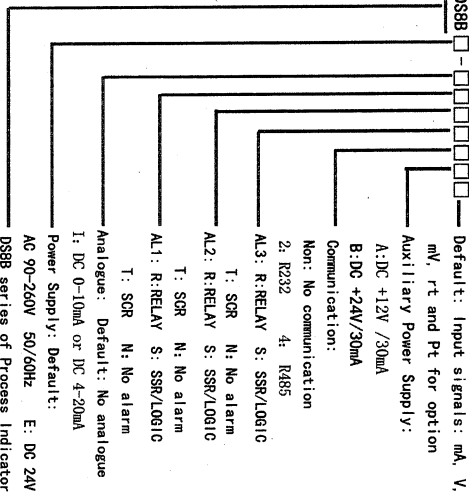

Specifications

Power supply	90-260V AC or 18-30V AC/DC
Consumption	$\leq 5VA$ 0.3Wf ± 2 digit
Accuracy	
Sampling rate	≤ 8 times/second
Alarm	Relay: NO AC 250V/3A or DC 30V/3A cos = 1
Input	refer the input signal selection
Analogue output	refer the input signal selection
Auxiliary Power	DC 24V/30mA
Communication	RS232 or RS485 for option

Dimensions

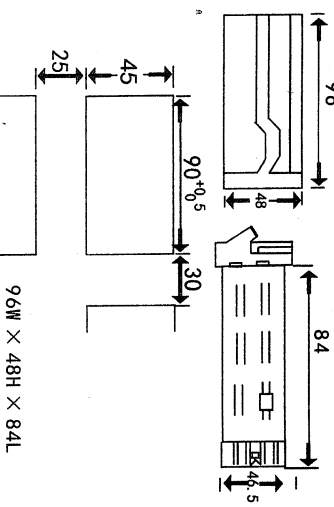

Parameter setting

- Alarm setting: In the displaying estate, press and hold SET key for more than 3 seconds, enter alarm mode parameters setting menu. Press <</RST key, LED flashes, press Δ / ∇ key to modify, and then press SET key to confirm. Press SET key to read the following parameters one by one.
 - Rate setting: In displaying estate, press <</RST key and LED flashes, then you can modify the value by Up and Down key. The factory setting is 1.00. Once the user want to set it to be other value, then PV=Rate X (USP-LSP) + LSP. USP means Up limit, LSP means Down limit.
 - Zero point clear: In the displaying estate, without key operation, when the input zero point, press and hold <</RST key for more than 2 seconds. It is for the sensor zero point clear.
 - The instrument will return to the measuring estate without any operation for 25 seconds.

Special Function

The instrument can be input by up to 2 signals. The up and down LED can display the measuring value. The instrument can calculate the two input value, so it also can be used as a watt meter.

Operation process

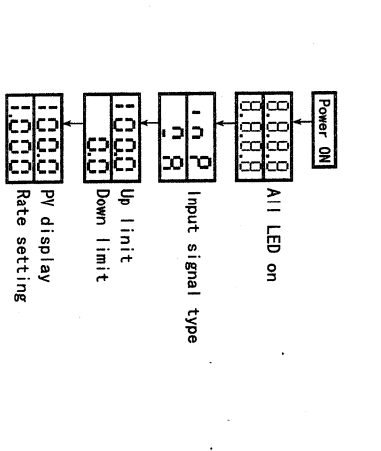

Alarm parameter setting

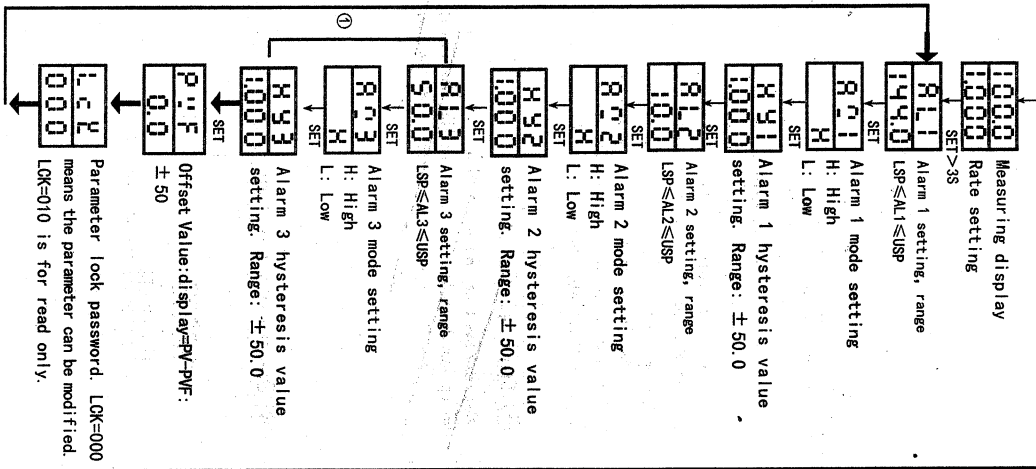

Press Δ / ∇ key for more than 3 seconds, can enter/quit from the second grade parameters setting

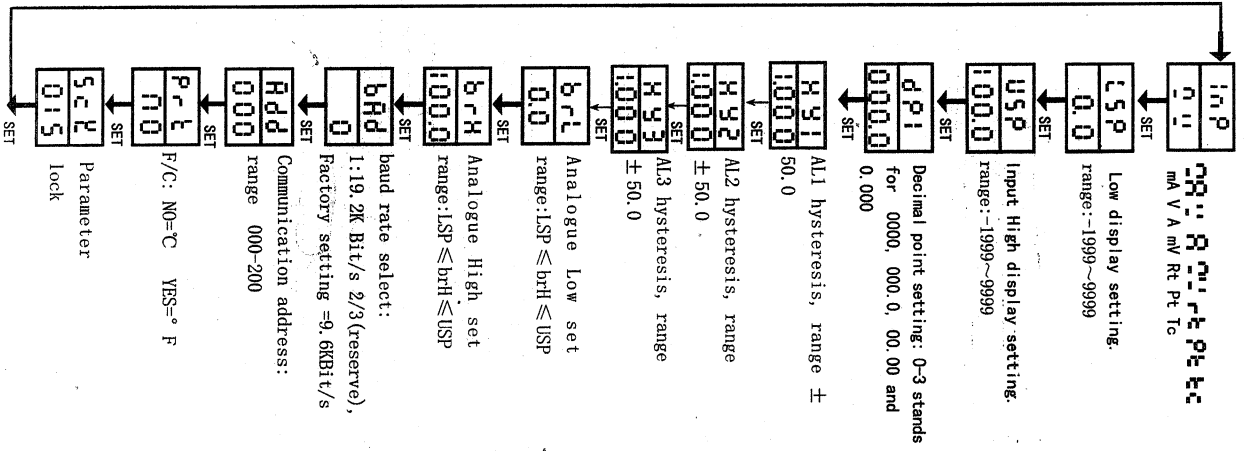
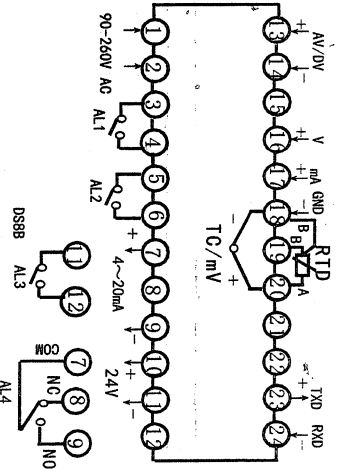

Diagram connections



Please subject to the diagram on the product, if any changes

Application examples

1、Used with 2 wire transmitter. The instrument can supply DC 24V auxiliary power, and isolate analogue output 4-20mA. Select input signal mA.

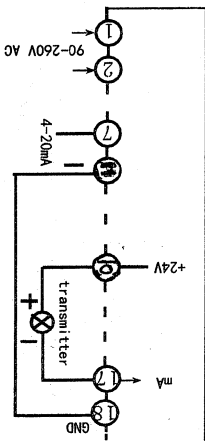

2、Used with pressure sensor. The instrument can supply DC 12V auxiliary power, and the sensor output is 2mV/V. Select input signal mV.

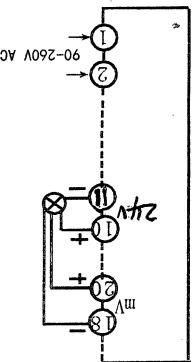

3、Used with Ohm meter. Input 0-400 Ohm. Select input signal rt.

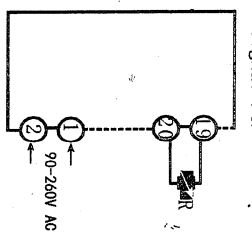

Malfunction estimate

- ① No display : Check all the connection and wiring if it is correct. Specially pay attention to the power supply terminals and signal input terminals, please do not wrong connect. As well pay attention to do not short the output terminals by strong current.
- ② Wrong display : Check it the PVF=0.00 Check if the input signal is conformity with the selected symbol.
For RTD input, please use low impedance cable. The 3 wires should at the same length.
- ③ Wrong control : When the instrument lost control, please check if the output diagram connection is correct. Or check if the components for output part damaged.
- ④ UUUU, LLLL : When the instrument displays "UUUU", it means the input signal exceeds the measured Lsp range. When the instrument displays "LLLL", it means the input signal lower the measured Lsp range, or input signal terminal connection is contrary.