

# **Portable Vibration Tester**

## **Instruction Manual**

## Contents

1 General Descriptions.....	1
1.1 Basic working principle.....	1
1.2 Application range.....	1
1.3 Technical Specifications.....	1
1.4 Basic configuration and Optional accessories.....	2
1.5 Other parameters.....	3
1.6 Features.....	3
2 Technical terms.....	4
3. Configuration.....	6
4. Installation of Transducer .....	7
4.1 Installation principle.....	7
4.2 Install method.....	7
4.3 System operation .....	11
4.4 Analyse .....	18
4.5 View .....	20
5. How to use the accessories.....	21

6. Trouble shooting.....	21
7. Maintenance.....	22

# 1 General Descriptions

## 1.1. Basic working principle

The portable vibration tester uses piezoelectric acceleration transducer to convert vibration signal into electric signal. Then by analyzing input signal, results including RMS of velocity values, peak-peak value of displacement, peak values of acceleration or real-time spectral charts are displayed or printed out.

## 1.2. Application range

The vibration meter is designed to test conventional vibration, especially the vibration test in rotating and reciprocating machines. It can be used not only to test the acceleration, velocity, and displacement of vibration but also perform simple failure diagnosis.

The technical specifications of the tester comply with the requirements of GB 13823.3. It is widely used in machinery, power, metallurgy, automobile and other industrial fields.

## 1.3. Technical Specifications

- Measurement range

Acceleration:                    0.1 m/s<sup>2</sup> ~ 200.0 m/s<sup>2</sup>        (Peak)

Velocity:                         0.1 ~ 400.0 mm/s                (RMS)

Displacement: 0.001 ~ 10.0 mm (Peak – peak)

- The frequency range

Acceleration: 10Hz ~ 200 Hz, 10Hz ~ 500 Hz, 10 Hz ~ 1KHz, 10 Hz ~ 10KHz

Velocity: 10Hz ~ 200 Hz, 10Hz ~ 500 Hz, 10 Hz ~ 1KHz

Displacement: 100Hz ~ 200 Hz, 10Hz ~ 500 Hz

- Accuracy:  $\leq \pm 5\%$
- Temperature range: 0°C ~ 40°C
- Humidity range:  $\leq 80\%$  RH

#### **1.4. Basic configuration and Optional accessories**

- Basic configuration

Title	Quantity
Main body	1
9V/1000mA power adapters	1
Vibration transducer	1
Package case	1
Manual	1

- Optional accessories

Title	Quantity
Data Management software	1
Magnetic base	1
Probe groupware	1
Laser transducer	1

### **1.5. Other parameters**

- Display screen: Colour TFT, 320×240 pixels
- Battery's parameters: Li battery, work 40 hours continuously. Charging time 10 hours.
- Dimensions: 212mm×80mm×32mm
- Weight: 260g

### **1.6. Features**

- Three display modes: Common mode, Spectrum mode and Rev mode.
- The acceleration, velocity, displacement of vibration and Rev can be tested.

- The testing meter can display measurement values in colour character according to alarm limit and warning limit.
- Measurement value and spectral charts can be printed out.
- Connecting with PC ( with the software),updating and memory of data is available and as well as the drawing of trend chart.
- Memory function: It can store 100×80 measurement values and 100 spectral charts.
- Li battery is used: The battery can charge at anytime safely and it can work continuously for a long time after charging is finish.

## **2 Technical terms**

1. Vibration: A rapid linear motion of object about an equilibrium position, like piston, tuning fork or motor.
2. Vibration displacement: The magnitude of a vector from the initial position to a subsequent position assumed by a body.
3. Vibration velocity: The rate of speed of vibration.
4. Vibration acceleration: The rate of change of vibration velocity with respect to time.
5. Vibration frequency: The number of complete cycles of vibration per unit time.

6. Point number: One point number correspond to one testing point.
7. Patrol test: Test more than one point in a fixed routine. Each point correspond one testing point.
8. Warning limit: Remind users that the vibration is beyond the limit of the safe state.
9. Alarming limit: Remind users that the vibration is beyond the limit of the destruct status.
10. RMS, peak values and peak-peak values (see Figure 2-1)
11. Spectral chart: A chart indicates the magnitude distribution of each frequency in the whole vibration.

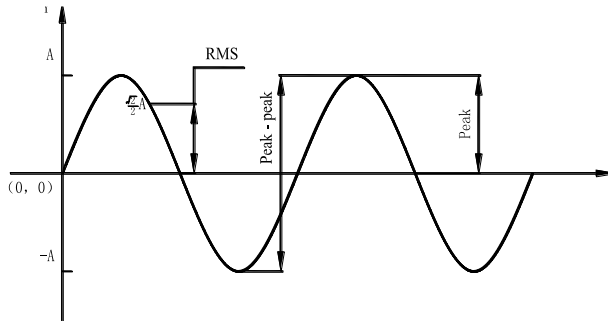

Figure 2-1



### 3 Configuration

#### Description of components

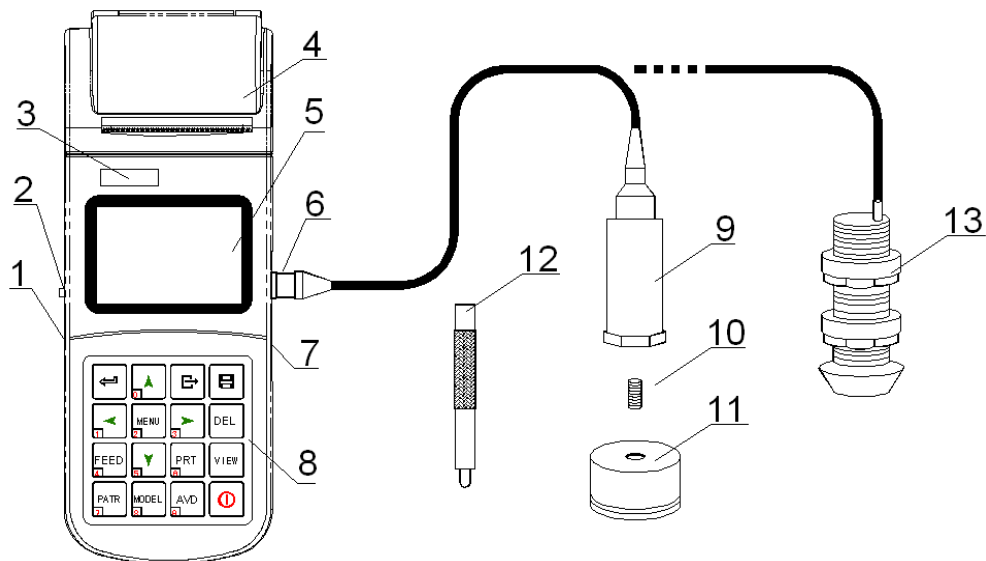

Figure 3-1

- 1 Socket of transducer
- 2 Socket of USB
- 3 LOGO
- 4 Paper compartment cover
- 5 Viewing Area
- 6 Keypad
- 7 Battery switch
- 8 Power jack
- 9 Vibration transducer
- 10 Connect Bolt
- 11 Magnetic base
- 12 Probe groupware
- 13 Laser transducer

*According to different situations, the transducers maybe fixed in the probe groupware or connected to the magnetic base (see chapter 4 in detail.).*

## **4. Installation of Transducer**

### **4.1 Installation principle**

- The testing position should show the vibration characters of the object to be tested.
- The main axis of the transducers should be consistent with the direction of he object to be tested.
- The transducers should be in close contact with the object to be tested.

### **4.2 Install method**

tall thod Contrast	Ins me	Install with bolts	Install with magnetic base	Install with probe
	Cost	None	low	Rather high
Affection on the result	None	When roughness is worse than Ra1.6, the result maybe not stable.	When caring about acceleration and the vibration frequency is higher than 1KHz, the result will be smaller.	
Convenience	Not good	good	Best	

#### 4.2.1 Installed with bolt

Application range: Screw eye has no influence on the running of the object being tested.

Usage: Drill a screw eye 5mm deep in the object being tested. Connect the transducer to the object by bolts. And this is the method that the frequency response is best.

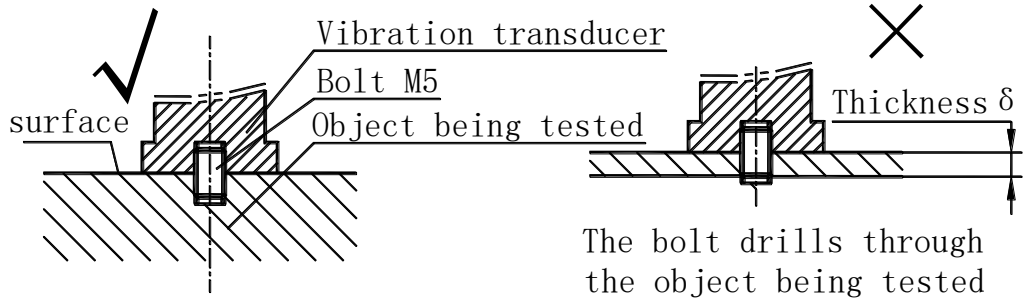

Figure 3.2

#### 4.2.2 Installed with magnetic base

Application range: Magnetic, flat surface, roughness less than Ra1.6, acceleration less than 20 m/s<sup>2</sup>.

Usage: Before using, take off the iron wafer and rubber wafer under magnetic base (ensure enough suction), adsorbed on the object being tested and then screw up the magnetic base on transducer (see Figure 4-2). After usage, put back the iron wafer and rubber wafer to maintain the magnetism.

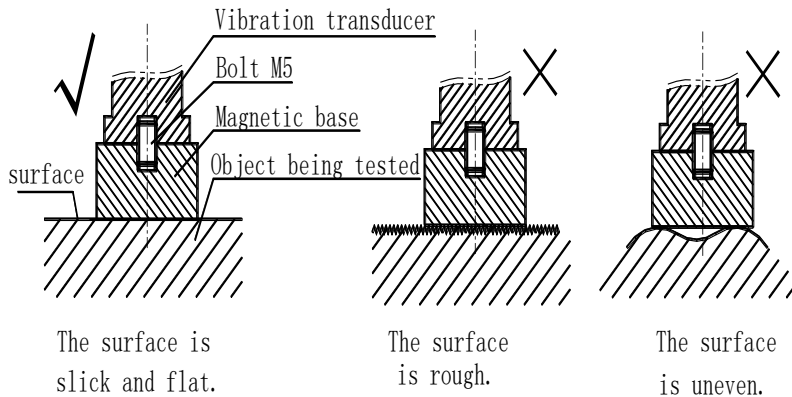

Figure 3.3

### 4.2.3 Installed with probe

Applications range: Frequency is less than 1KHz; vibration energy is not too small.

Usage: Connect the needle to the transducer directly by using probe groupware (see figure 4-3)

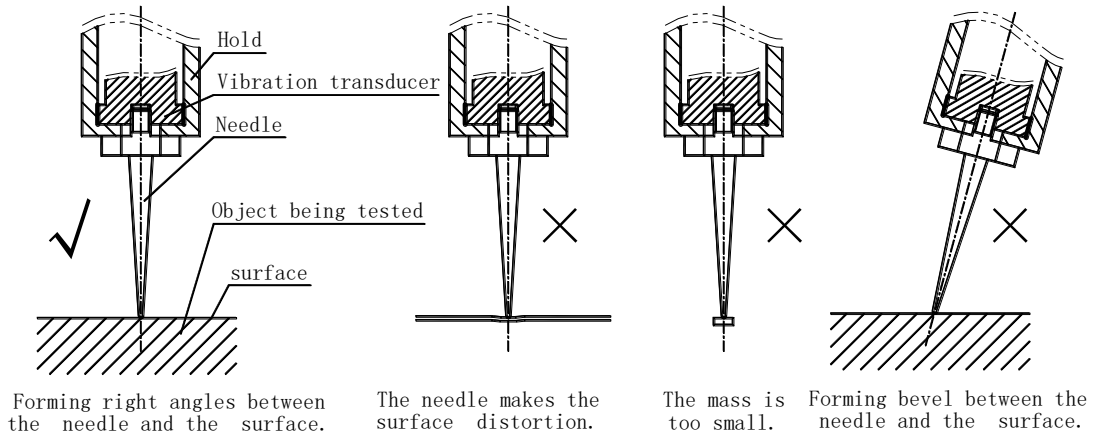

















Figure 3.4





### 4.3 System operation







In this chapter, it give a brief introduction of keys (refer to Table 4.1) and menu(Figure 4.2)

Table 4.1

key	Name	Key	Name	Key	Name	Key	Name
	Enter key		Up key “1”		Back key		Save key
	Left key”1”		Menu Key “2”		Right key “3”		Delete Key
	Feed Key		Down key “3”		Print key “8”		Review Key
	Patrol		Model key “4”		parameter key “9”		Power

Description:

- Power: Press  to switch on/off the meter.
- Measure: Press  to enter into measurement, and Press  to end measurement; if the Auto Save is on ,then auto save the mensure data,or Press  to save the measured data.

- Data delete: Press  to delete the stored measurement result.
- Data view: Press  to review the stored measurement result.
- Paper feed: Press  to feed the paper.
- Data print: Press  to print the current measured result or the stored measurement result.
- Point patrol: Press  to switch on/off the point patrol function.
- Measure model: Press  to select the measure model: Common model, Spectrum model and Rev model(refer to Figure 4.1a, Figure 4.1b, Figure 4.1c).

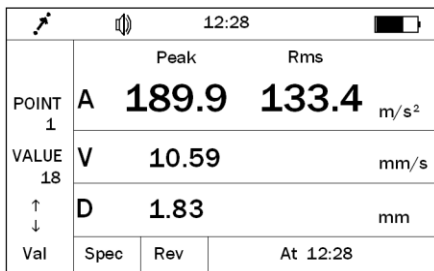

Figure 4.1a Common mode

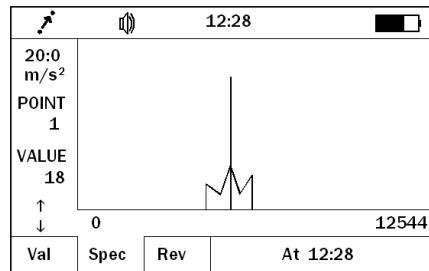

Figure 4.1b Special mode



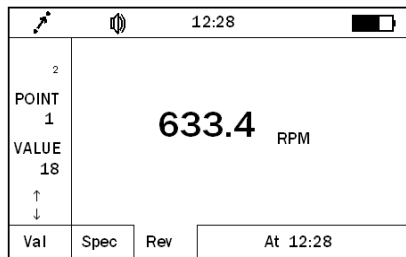

Figure 4.1c Rev mode

- Mmeasure parameter: Press  to select the measure parameter: Acceleration, velocity and displacement. (refer to Table 4.2).

Table 4.2 reference table for measurement parameters

Main parameters	Acceleration	Speed	Displacement
Available transmission bands	10-200Hz 10-500Hz 10-1kHz 10-10kHz	10-200Hz 10-500Hz 10-1kHz	10-200Hz 10-500Hz
Default warning limit	200 m/s <sup>2</sup>	400 mm/s	10.0mm
Default alarm limit	200m/s <sup>2</sup>	400 cm/s	10.0mm





- System parameters setting: Press  to enter into mainmenu, Press  and  to select submenu, Press  to confirm operation or enter into submenu. Press  to cancel or return last menu (refer to Figure 4.2).

Figure 4.2 Menu figuration



**Battery indicator:** display the remaining electric quantity.

**Operation tips:** when the battery is low, please charge it in time, or it will cause the accuracy of the measurement.

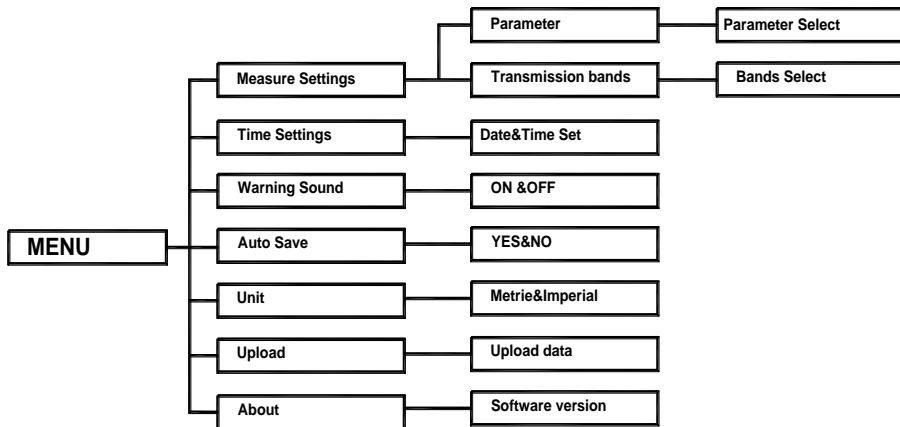
**Measuring status:** there is measurement and non-measurement mode;

In measurement status, the process bar will display “ ■ ■ ■ ” ;

In non-measurement status, it will display the latest measurement time, for example “09:20”;

Time: display the current system time

**Point number:** the point number related to the current measured information

**Display area:** there are three display modes, including common, special and spectrum.

**Common mode:** show the main parameters(see figure 4.1a)

**Spectrum mode:** show the spectrum chart (see figure4.1b)

**Rev mode:** show the Rev value(see figure 4.1c)

**Main parameters:** select velocity, displacement and acceleration

**Transmission bands:** after the selection of the main parameters, users can select the corresponding bandwidth.

**Warning limit:** you need to preset the warning limit and alarm limit, During measurement, if

you select common and Spectrum mode, when the measured value is higher than the warning limit, the system will prompt to alarm.

Operation tips:

- (1) If the preset of warning value exceeds the preset of alarming value the system will set “warning value” =“alarming value” automatically.
- (2) If the preset value exceeds the default value of table 4.2,system will set “preset value”=“default value”.

#### 4.3.1 Point patrol:

If point patrol is disable, the point number will not increase automatically. When tests are performed continuously, the measurement results will be regarded as different testing results of the same testing point number.

If point patrol is enable ,when a testing operation of the current point number is finished, the point number will increase automatically, and go into the waiting state of the next point number. Up/Down keys can also change the testing point number. For example, after the point number 1 measurement is finished, the system will automatically enter the point number 2 and wait for measurement, after the

second measurement, it will automatically enter point number 3. It is much more convenient when you need to perform continuous measurement of many points.

#### 4.3.2 Time setting

This tester can automatically record the time when the test is performed. If the time is not correct, it should be reset manually.

#### 4.3.3 Software information

It displays the software version and serial number.

### 4.4 Analyse

Figure 4.3 shows that the “Analyse” menu consists of “Print”, “Auto”, “Manual” and “Zoom” four sub items. Figure 4.3 show the analyse interface.

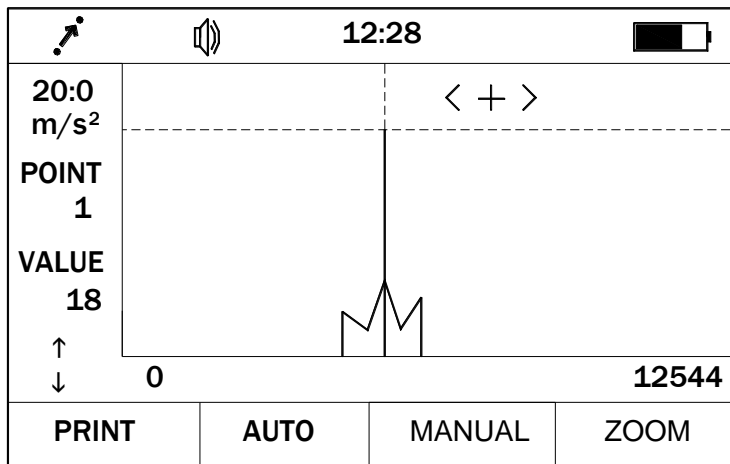



Figure 4.3



#### 4.4.1 Print

The current displayed spectrum chart can be printed .







#### 4.4.2 Auto

Press  or  to move cursor and the system will automatically capture the peak value and the corresponding frequency as well as amplitude.

#### 4.43 Manual

The values of different points in the charts can be looked through in the manual style. Press  and  to move cursor to display the frequency and amplitude of the point which the cursor pointed.

#### 4.4.4 Zoom

In spectrum analysis, the spectrum zoom function can change the frequency resolution in the range selected by users. Firstly, to select the range of the frequency----that is the concerned area, press  or  keys to move the cursor. The cursor could move more quickly when the  or  key is hold. Secondly,  and  keys could change the frequency resolution. The resolution could reach 0.25Hz.

#### 4.5 View

Users can look through the measurement results stored in the memory by press  key. The information of each measurement result comprises point number, testing time , certain results, unit and whether the measured results is higher than the waning limit. Users could print out the list. Also, the data can be deleted.

## **5. How to use the accessories**

The tester has accessories such as printer and corresponding software. If equipped with printer, the printing operation can be performed. The data stored in the tester can be uploading to PC and do analysis with corresponding software. If PC is equipped with printer, the data can also be printed out from PC.

The tester connects to printer or PC through a communication cable. One end is connected to it through RS232 serial port, and the other end is connected to printer or PC through a 9-pin connector. How to use the software can refer to the specifications of the corresponding software.

## **6. Trouble shooting**

- When the battery cannot charge, check the charging indicating light.
- The measurement value is unstable.
  1. Make sure the vibration frequency of the vibration object is in the frequency range of 10Hz—10kHz.
  2. If the magnetic base is used, pay attention to:
    - a. Make sure the surface of the tested object is flat, and roughness is smaller than Ra1.6.
    - b. Make sure the iron wafer below the magnetic base is taken off, and the magnetic force is enough.



- When enter the non-mother language system because of incorrect operation, users can change back the mother language referring to the construction of the menu (see 5.3).

If some trouble cannot be overcome, please contact to us.

## **7. Maintenance**

1. **Operating environment:** Strictly avoid collision, heavy dust, dampness, strong magnetic field, oil, grease and dirt.
2. **How to clean the main body of the meter:** Because alcohol and other chemical liquid can erode the main body of tester, especial the display window, little water can be used to clean to meter smoothly.
3. **How to use the connector:** Don't plug the connector of the transducers, printer or PC, when tester is power on.
4. **Calibration:** The vibration meter is a high-precision instrument and the environment will influence on it. So it should be calibrated periodically (half a year or one year). If the sensitivity has changed, it can be adjusted by rotating the knob which is use to adjust the sensitivity.
5. **Electromagnetic influence:** when the electromagnetic field is over 10 V/m, the accuracy of testing will be influenced.

c8. Non-warranty Parts

Appendix 1: Vibration standard

**a. Rank of machine vibration (ISO2372)**

Vibration amplitude	Machine sort			
Vibration Velocity $V_{rms}$ (mm/s)	I	II	III	IV
0~0.28	A	A	A	A
0.28~0.45				
0.45~0.71				
0.71~1.12	B	B	B	A
1.12~1.8				
1.8~2.8	C	C	B	B
2.8~4.5				
4.5~7.1	D	C	C	C
7.1~11.2				
11.2~18				
18~28		D	D	D
28~45				
>45				

Note: (1) Class I is small motor (power less than 15kW). Class II is medium motor (power between 15kW~75kW). Class III is high power motor (hard base); Class IV is high power motor (stretch base).

(2) A, B, C, D are vibration rank. “A” means good, “B” means satisfying, “C” means not satisfying, “D” means forbidden. Vibration velocity should be taken from the three perpendicular axes on the motor shell.

**b. Maximum vibration of motor that power larger than 1 horsepower (NEMA MG1-12.05)**

Rev (rpm)	Displacement (p-p)(um)
3000~4000	25.4
1500~2999	38.1
1000~1499	50.8
≤999	63.6

\* For AC motor, rev is maximum synchronous rev. For DC motor, it is maximum power rev. For motor in series, it is work rev.

**c. Maximum vibration of high-power induction drive motor (NEMA MG1-20.52)**

Rev (rpm)	Vibration displacement (p-p)(um)
≥3000	25.4
1500~2999	50.8
1000-1499	63.6
≤999	76.2

\*National Electric Manufacturers Association (NEMA) establishes two standards above.

**d. Maximum vibration of squirrel-cage induction drive motor (API STD 541)**

Synchronous rev (rpm)	Vibration displacement (p-p)(um)	
	Stretch base	Hard base
720~1499	50.8	63.6
1500~2999	38.1	50.8
≥3000	25.4	25.4

\*American Petroleum Institute (API) established this standard.

**e. ISO/IS2373 Motor quality standard according as vibration velocity.**

Quality rank	Rev (rpm)	H: High of shaft (mm)		
		Maximum vibration velocity (rms)(mm/s)		
		80<H<132	132<H<225	225<H<400
Normal (N)	600~3600	1.8	2.8	4.5
Good (R)	600~1800	0.71	1.12	1.8
	1800~3600	1.12	1.8	2.8
Excellent (S)	600~1800	0.45	0.71	1.12
	1800~3600	0.71	1.12	1.8

Limit of rank “N” is suitable for common motor. When the request is higher than that in the table, limit can be gotten by dividing the limit of rank “S” with 1.6 or multiples of 1.6.

## Appendix 2 Vibration frequency and possible reason

Vibration frequency	Most possible reason	Other possible reason	Note
Synchronous with $f_s$ *	Imbalance	1) Eccentric of gear, belt sheave and bush 2) Shaft is not in the middle or curving (if vibration on the shaft direction is high), 3) Belt fault 4) Syntony 5) Reciprocate force	
Double $f_s$	Mechanical loose	1) Shaft is not in the middle or curving (if vibration on the shaft direction is high), 2) Belt fault 3) Syntony 4) Reciprocate force	
Triple $f_s$	Not in middle		
N multiple of $f_s$	Gear fault, liquid force, mechanical	$1 \times N \times f_s$ (N is the tooth number of the fault gear).	If loose is worse, there

	loose, reciprocating force	$2 \times N \times f_s$ (N is the paddle number of the fault pump or fan)	maybe higher multiple frequency.
$< f_s$	Oil film eddy turbulence	1) Drive belt fault 2) Interferential vibration 3) Beat frequency	
Synchronous with power frequency	Armature fault	Electric fault such as rotor broken, rotor eccentric, three phase imbalance and air clearance not symmetry	
Double the power frequency	Torsional impulse		Seldom
High frequency (not multiple of $f_s$ )	Shaft is not lubricate	1) Cavitations and turbulent flow 2) Frictional force	Amplitude and frequency of vibration are always not steady.

\*  $f_s$  is the frequency according with the rev of main shaft.